

MODULARITÀ

N.B. - LE ALTEZZE DI TUTTI GLI ELEMENTI SONO COMPRESIVE DI PIEDINI REGOLABILI (H.6±30 mm)

BASI A TERRA: H. 88.1

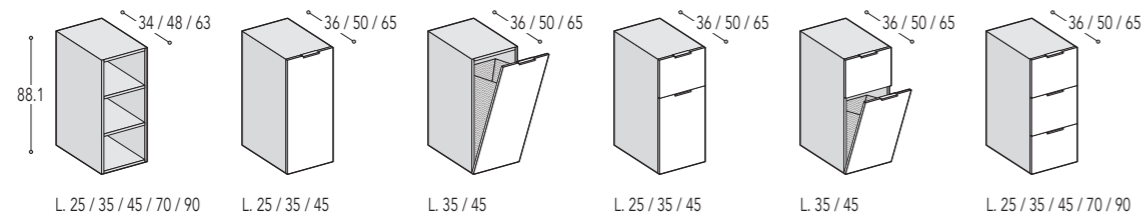

BASI A TERRA: H. 88.1

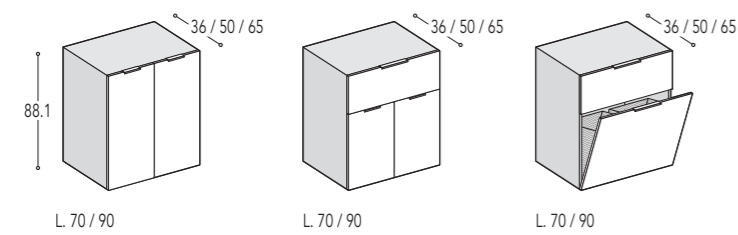

BASE P/LAVATRICE A TERRA: H. 88.1

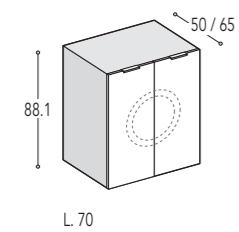

BASI P/VASCA a TERRA: H. 88.1

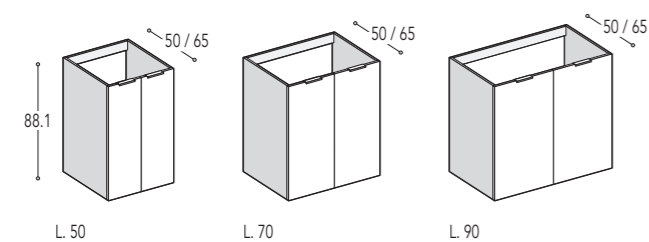

MODULARITÀ

N.B. - LE ALTEZZE DI TUTTI GLI ELEMENTI SONO COMPRESIVE DI PIEDINI REGOLABILI (H.6±30 mm)

LAVATOI H.88.1 con VASCA IN CERAMICA

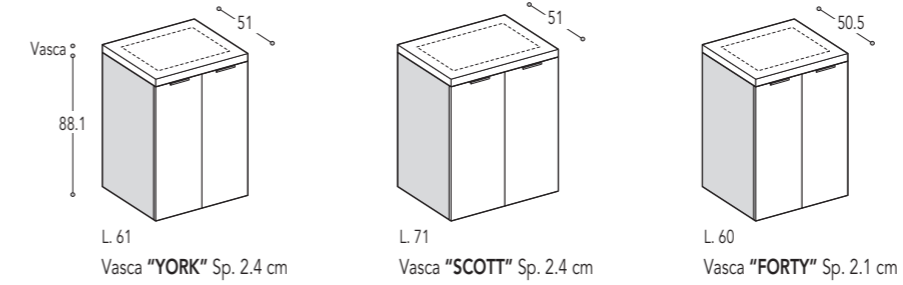

LAVATOI H.88.1 con VASCA IN MINERALMARMO "NIC" Sp.2.2 cm

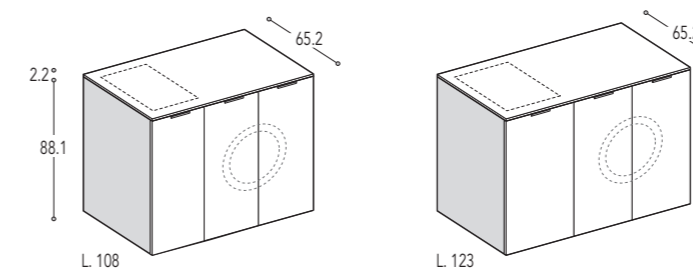

LAVATOI H.88.1 con VASCA IN METACRILATO "YDRO" Sp.3 cm

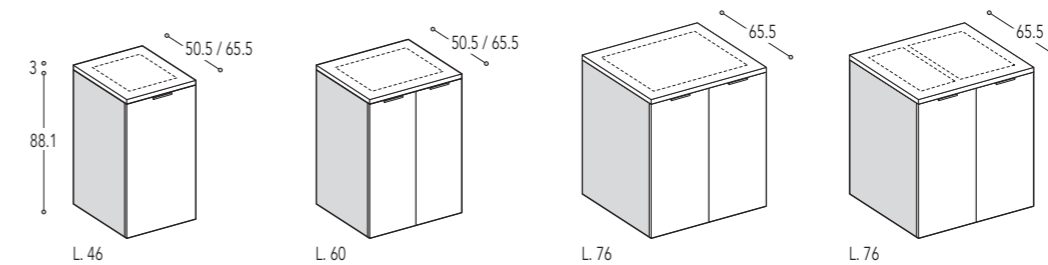

LAVATOI H.88.1 con VASCA IN METACRILATO "YDRO" Sp.3 cm

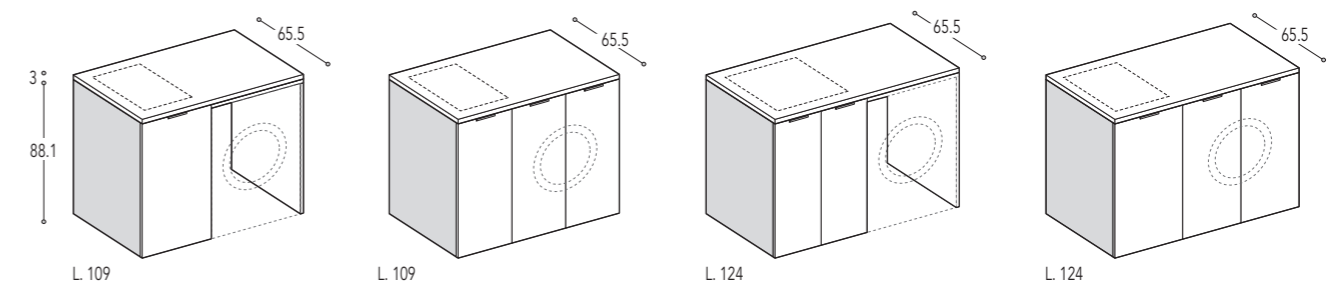

MODULARITÀ

N.B. - LE ALTEZZE DI TUTTI GLI ELEMENTI SONO COMPRESIVE DI PIEDINI REGOLABILI (H.6±30 mm)

PENSILI: H. 70

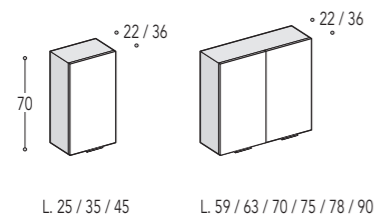

PENSILI SPECCHIO CONTENITORE: H. 70

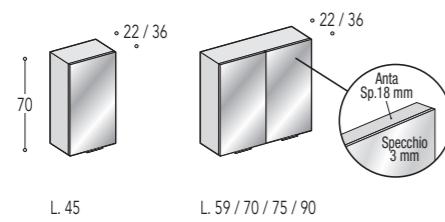

SEMI-COLONNE A TERRA: H. 117

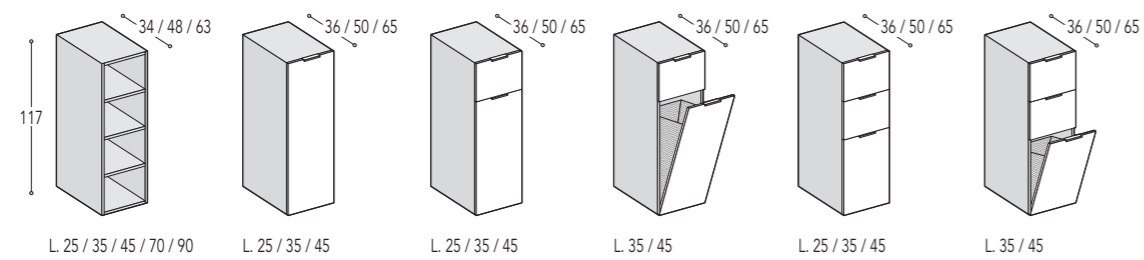

SEMI-COLONNE A TERRA: H. 117

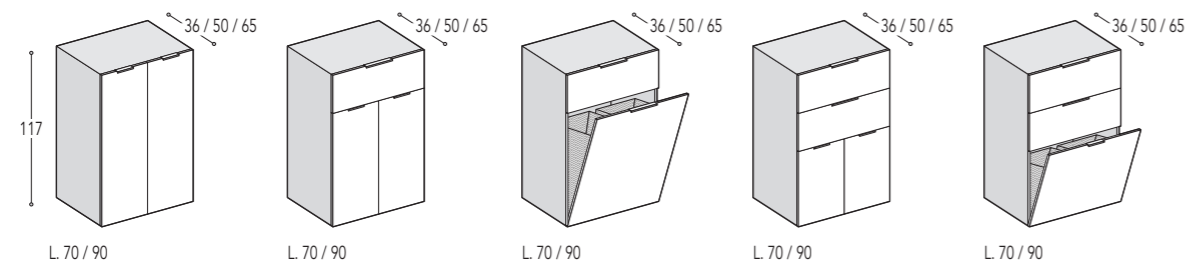

MODULARITÀ

N.B. - LE ALTEZZE DI TUTTI GLI ELEMENTI SONO COMPRESIVE DI PIEDINI REGOLABILI (H.6±30 mm)

COLONNE A TERRA: H. 203.4

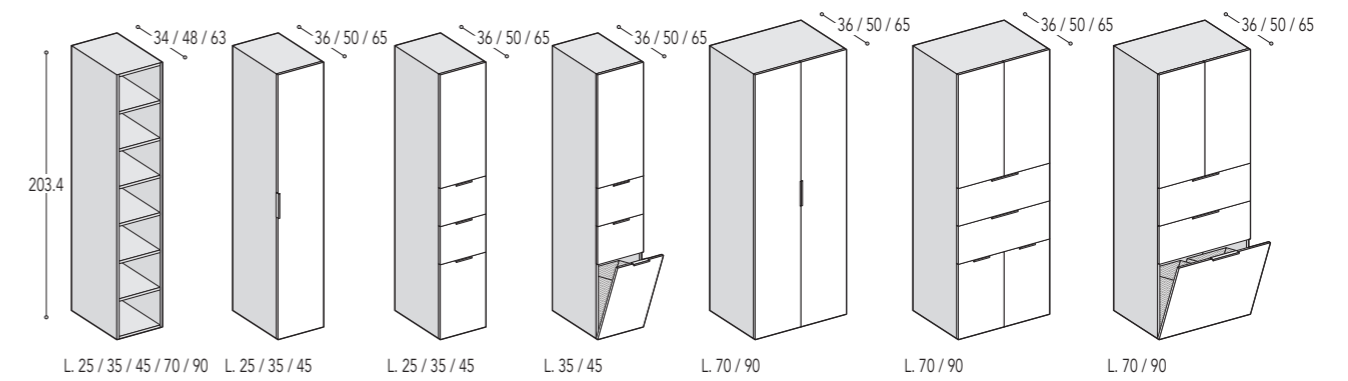

COLONNE P/SCOPE A TERRA: H. 203.4

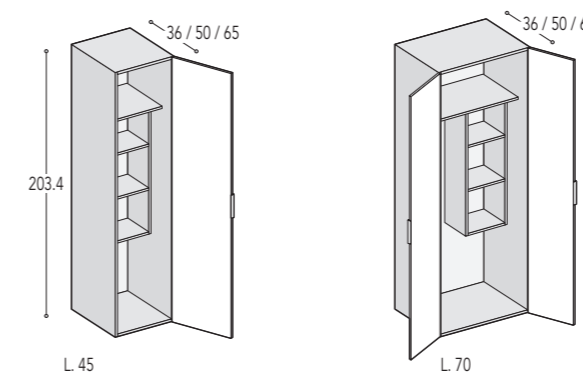

COLONNA PORTA ASSE DA STIRO A TERRA: H.203.4

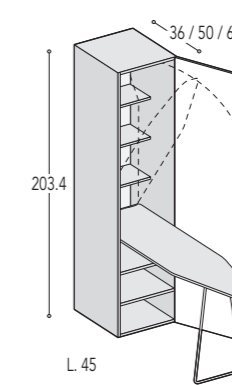

COLONNE P/LAVATRICE A TERRA: H. 203.4

